

SV3420D-PLS2		
Continuous Torque	7.91	in-lb
	126	oz-in
	0.89	N-m
Peak Torque	24.91	in-lb
	399	oz-in
	2.81	N-m
Nominal Continuous Power	324	Watt
No Load Speed	4,500	RPM
Continuous Current @ Nominal Power	9.4	Amps
Voltage Constant	10.8	V/kRPM
Winding Resistance	1.2	ohms
Encoder Resolution	8,000	Counts/Rev
Rotor Inertia	0.013	oz-in-sec <sup>2</sup>
	9.183	10 <sup>-6</sup> Kg-m <sup>2</sup>
Weight	3.5	lb
	1.59	kg
Shaft Diameter	0.375	in
	9.53	mm
Shaft, Radial Load	15	lb
	6.80	kg
Shaft, Axial Thrust Load	3	lb
	1.36	kg
EtherNet Available		
DeviceNet Available	Yes	
ProfiBus Available	Yes	
CanOpen Available		

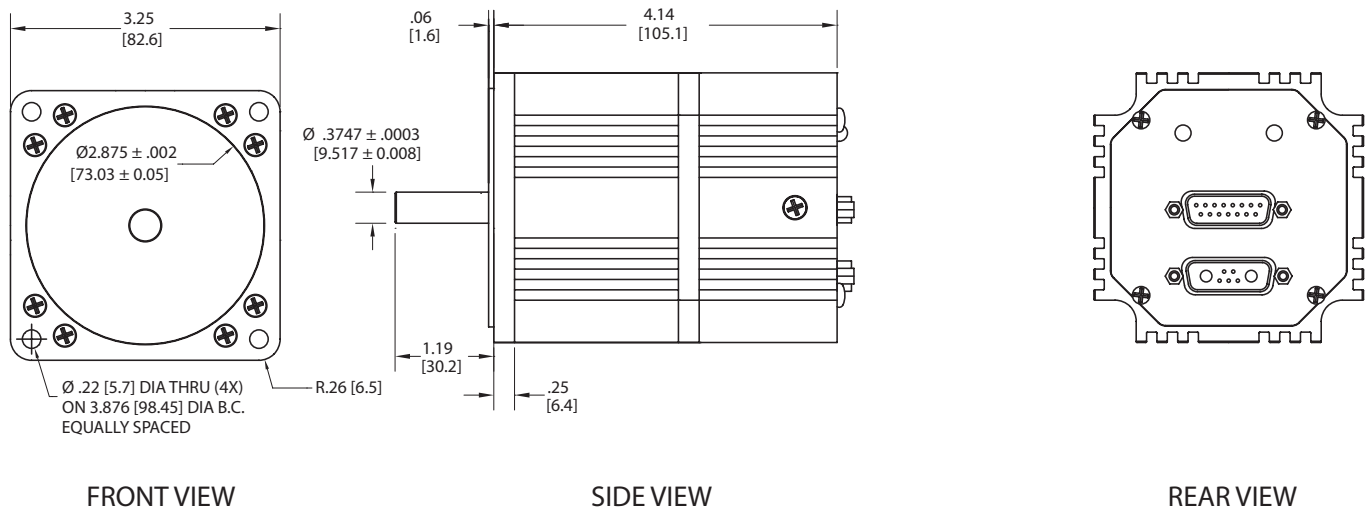

## Servida Motor SV3420D-PLS2 (No Options) CAD Drawing

in [mm]



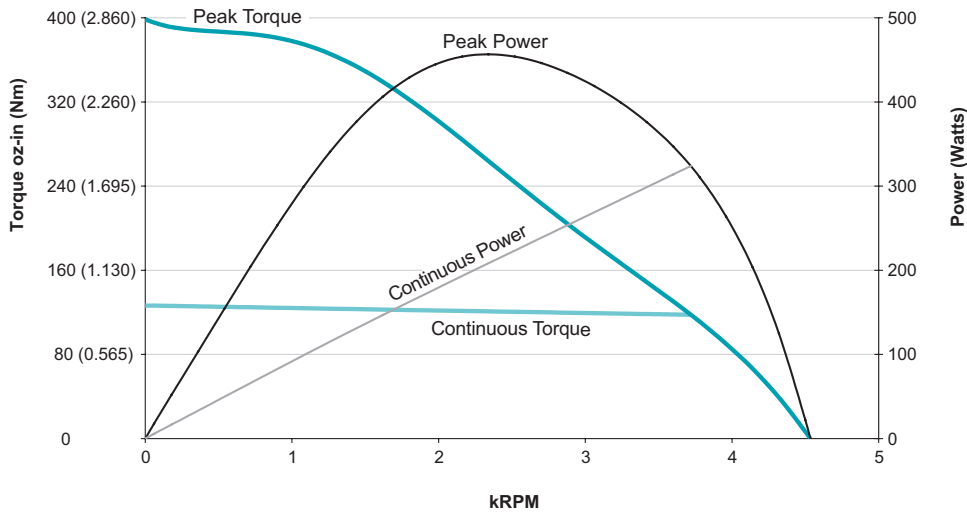

**SV3420D-PLS2  
at 48 VDC  
at rise to 85°C**

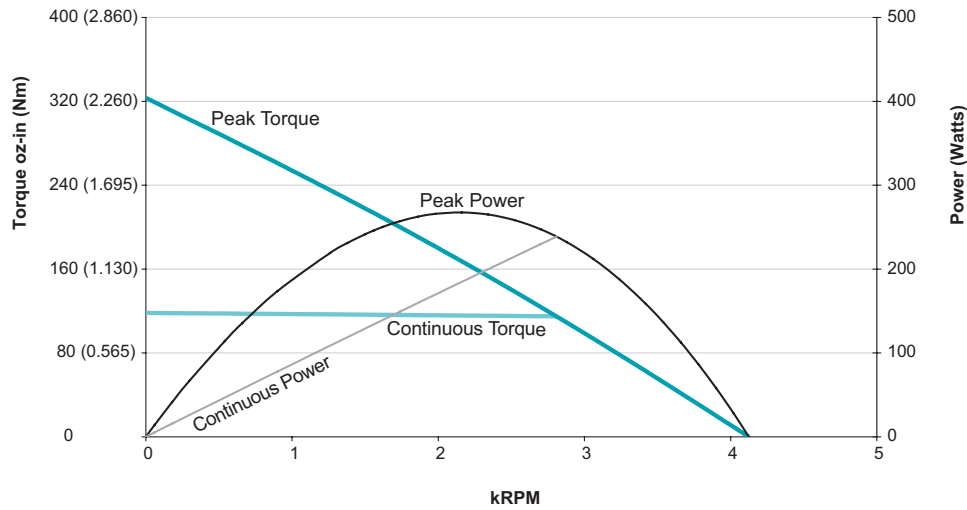

**SV3420D-PLS2  
at 42 VDC  
at rise to 85°C**

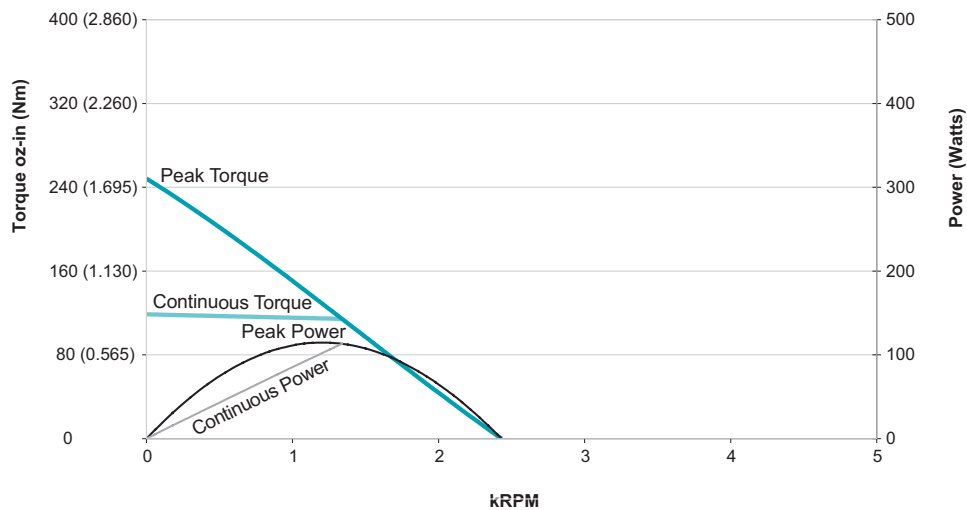

**SV3420D-PLS2  
at 24 VDC  
at rise to 85°C**