

RS-232 Communications with Power Supply & Protective Shunt

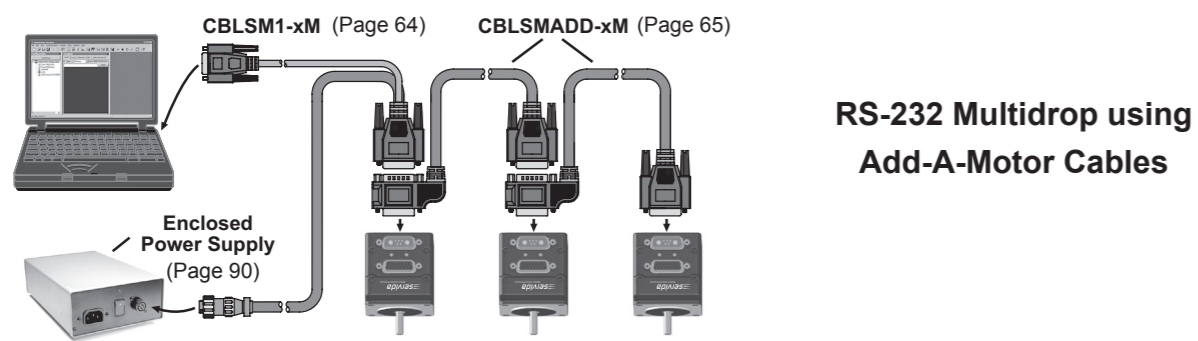

RS-232 Multidrop using Custom Order Cable

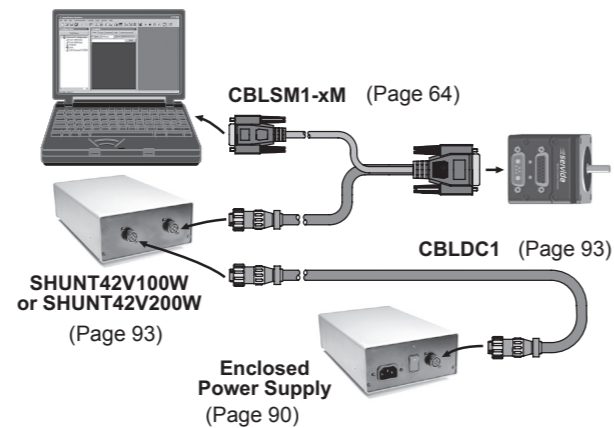
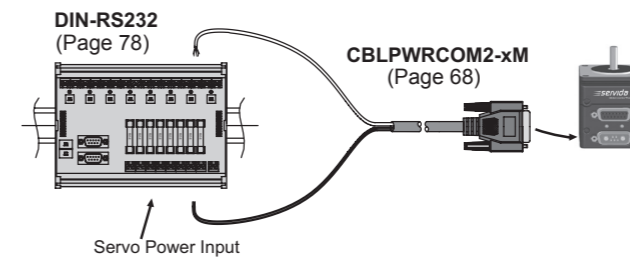
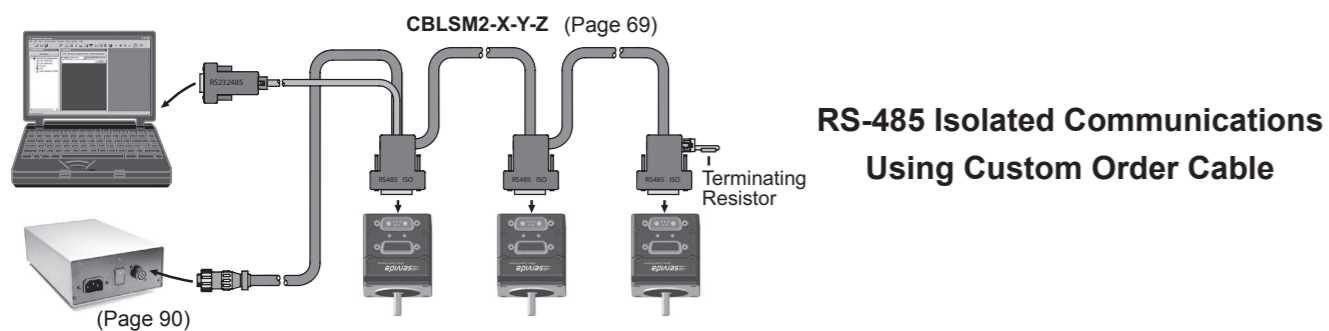
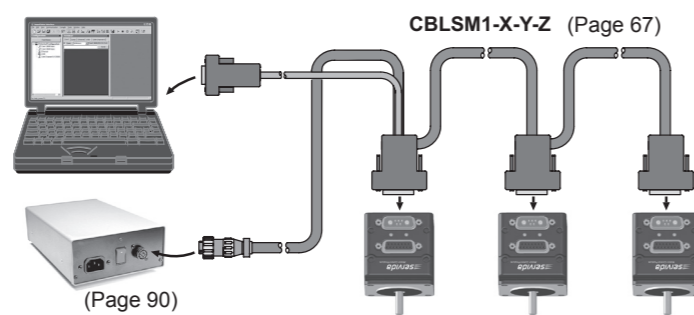

Demonstration & Development Configurations

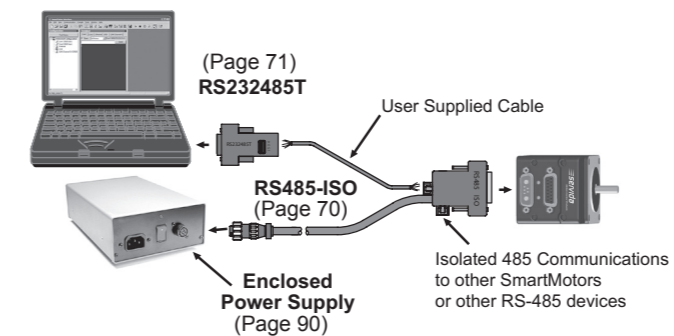
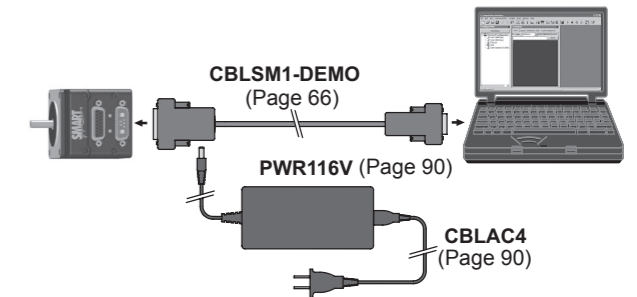

Interfacing with 24V I/O Devices

